



03 2022 BMW India Pvt. Ltd. Printed in India 2021.



# THE X5



For more information, call 1800 102 2269.

The models, equipment and possible vehicle configurations illustrated in this brochure may differ from vehicles supplied in the Indian market. For precise information, please contact your local Authorised BMW Dealer. Subject to change in design and equipment. © BMW India Pvt. Ltd., Gurgaon, India. Not to be reproduced wholly or in part without written permission of BMW India Pvt. Ltd., Gurgaon, India. [f/bmwindia](#) [You Tube /bmwindia](#) [t/bmwindia](#) [bmwindia\\_official](#) [/bmwindia](#)

THE BMW X5



# THE BMW X5.



DISCOVER  
MORE.



Scan the code to get more information,  
more driving pleasure on the BMW X5.

# INNOVATION AND TECHNOLOGY.



15 Dynamics and Efficiency  
16 Drivetrain and Suspension



17 Connectivity and Driver Assistance  
19 Safety



21 Models and Lines

# EQUIPMENT.



27 Equipment Highlights



33 Original BMW Accessories



35 Wheels and Tyres



41 Exterior Colours

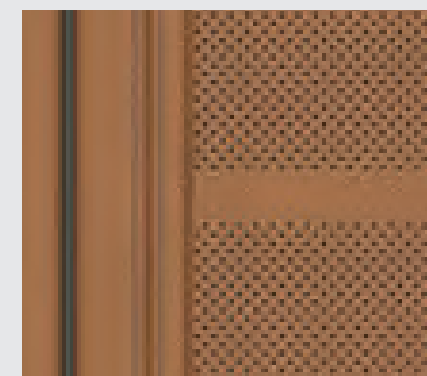

41 Interior Colours

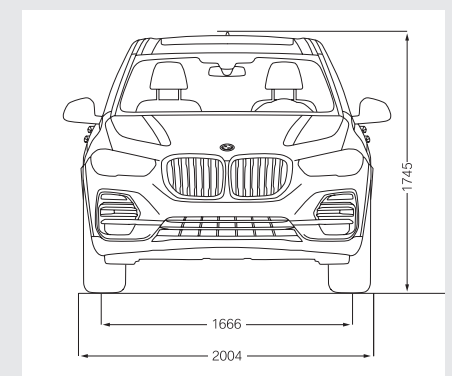

43 Technical Data



---

## EVERYTHING. MULTIPLIED BY X.

---

- POWERFUL STANCE • BMW ONE-PIECE KIDNEY GRILLE • BMW LASERLIGHT WITH X SIGNATURE
- 20" LIGHT ALLOY WHEELS



---

## LEAVE A POWERFUL IMPACT.

---

- FULL-LED REAR LIGHTS • REAR APRON WITH DIFFUSER
- TWO-PART ELECTRIC TAILGATE • CHARACTER LINES WITH S-CURVE

---

# GET IN. AT THE HIGHEST LEVEL.

---

- PANORAMA GLASS ROOF • WELCOME LIGHT CARPET
- PARKING ASSISTANT • SURROUND VIEW CAMERA • REVERSING ASSISTANT
- BMW DISPLAY KEY





## BOSS EVEN FROM THE INSIDE.

- INNOVATIVE COCKPIT DESIGN • 'CRAFTED CLARITY'  
GLASS APPLICATION • COMFORT SEATS IN LEATHER  
'VERNASCA' • BMW LIVE COCKPIT PROFESSIONAL
- BMW GESTURE CONTROL • BMW HEAD UP DISPLAY

---

# MARK GOALS WITH AN X.

---

- BMW xDRIVE-THE INTELLIGENT ALL-WHEEL DRIVE SYSTEM • ADAPTIVE 2-AXLE AIR SUSPENSION • LAUNCH CONTROL FUNCTION





WHAT MAKES A BOSS?  
IT'S THE SEAT OF A LEADER.  
OF SOMEONE CAPABLE OF OVERCOMING ALL OBSTACLES.  
BEING ABLE TO SEE A PATH WHEN NO ONE ELSE DOES.  
NOT AFRAID OF WHAT LIES AHEAD.  
NOT AFRAID TO STAND OUT BUT MAKE A STAND.  
AND NOT AFRAID TO MAKE THEIR PRESENCE FELT.  
BUT TRAVEL THE UNKNOWN AND GO WHERE OTHERS ONLY DREAM OF.  
BRING THESE VIRTUES TOGETHER AND YOU HAVE THE BOSS.  
A CAR THAT'S DESIGNED TO TAKE YOU WHEREVER YOU PLEASE.  
A CAR DESIGNED TO BOSS EVERY ROAD.

---

THE BMW X5.  
BOSS EVERY ROAD.

---



# DYNAMICS AND EFFICIENCY.

**BMW EFFICIENT DYNAMICS.**  
LESS EMISSIONS. MORE DRIVING PLEASURE.

## MORE POWER FROM LESS FUEL.

The **BMW TwinPower Turbo engines** offer the greatest possible dynamic performance with the highest efficiency thanks to the latest injection systems, variable output control and sophisticated turbocharger technology. Whether diesel or petrol, and no matter how many cylinders, the engines from the BMW EfficientDynamics engine family allow markedly more agile power delivery and outstanding responsiveness even at low rpm, while being fuel-efficient and low in emissions.

## MORE SPEED, LESS WEIGHT.

**BMW EfficientLightweight** showcases the ultimate in efficient, dynamic driving. Thanks to the intelligent use of especially lightweight and stiff materials - such as aluminium in the chassis, high strength steel in the body or ultra modern magnesium alloys in the engine - fuel consumption is reduced, while driving performance and dynamics are improved.



## AERODYNAMICS.

In the new BMW X5, extensive measures reduce aerodynamic drag, e.g. the third-generation air vent control (Active Air Stream kidney grille). Together with numerous aerodynamic optimisations, such as a targeted air flow to reduce turbulence on the front wheel or the Air Blades at the rear, consumption and CO<sub>2</sub> emissions are effectively reduced.

## ACTIVE AIR STREAM KIDNEY GRILLE.

The Active Air Stream Kidney Grille opens and closes the air vents in the radiator grille according to the cooling requirements of the engine, the brakes and the air conditioning. At the same time, the system's movable kidney slats reduce air resistance when closed, thereby improving aerodynamics.

## DRIVING EXPERIENCE CONTROL INCL. ADAPTIVE MODE.

The Driving Experience Control offers the driver the choice between the standard COMFORT mode, ECO PRO Mode, geared towards efficiency, and SPORT mode, which enables even more dynamic driving. The new interactive function Adaptive Mode\* continuously adjusts the Dynamic Damper Control, the steering and the Steptronic transmission to suit the current driving situation.

IN THE BMW X5.

\* Only on select models.

# DRIVETRAIN AND SUSPENSION.



## BMW X5 xDrive30d

- BMW TwinPower Turbo 6-cylinder diesel engine
- 195 kW (265 hp) @4000 rpm and 620 Nm torque @1500-2500 rpm
- Acceleration: 0 -100 km/h: 6.5 s
- Top speed: 230 km/h
- Fuel economy km/l: 13.38<sup>1</sup>
- CO<sub>2</sub> emissions g/km: 188.0<sup>1</sup>

## BMW X5 xDrive40i

- BMW TwinPower Turbo 6-cylinder petrol engine
- 250 kW (340 hp) @5500-6500 rpm and 450 Nm torque @1500-5200 rpm
- Acceleration: 0 -100 km/h: 5.5 s
- Top speed: 243 km/h
- Fuel economy km/l: 11.24<sup>1</sup>
- CO<sub>2</sub> emissions g/km: 211.0<sup>1</sup>



The Adaptive 2-axle Air Suspension makes driving particularly comfortable with high driving dynamics and makes it easier to get in and out and load the vehicle. The air suspension automatically keeps the vehicle at a constant height regardless of the load. It can also be raised or lowered manually at the touch of a button.

The intelligent BMW xDrive all-wheel drive system smoothly and variably distributes drive power to the front and rear wheels for maximum traction, driving dynamics and safety in every driving situation. For even better agility, the electronically controlled power distribution for instance counterbalances oversteer or understeer on bends.

<sup>1</sup> Performance data as measured in the emission test done under controlled conditions of environment, driving cycle, fuel, etc. as specified in Rule 115 of Central Motor Vehicle Rules, 1989.

# CONNECTIVITY AND DRIVER ASSISTANCE.



The **BMW Live Cockpit Professional** with navigation function includes a high-quality display network consisting of a high-resolution 31.2 cm (12.3 inches) Info Display that can be operated by touch and a fully digital 31.2 cm (12.3 inches) instrument cluster.



The full-colour **BMW Head-Up Display** projects all information relevant to the journey directly into the driver's field of vision, thereby allowing him to fully concentrate on driving. Information such as the current speed, navigation directions, along with telephone and entertainment information is displayed.



The 31.2 cm (12.3 inches) **Multifunctional Instrument Display** allows a fully digital display of different content, in addition to speed and revs, including navigation instructions, radio/multimedia track lists and phone lists.



The **Parking Assistant with Surround View Camera** can handle the most difficult parking spots with ease. You can go in and out of parking spots with precision due to the system control the steering while you still have control of the accelerator, gears, and brakes. The **Reversing Assistant** supports you when reversing out of narrow lanes. Surround View includes rear view camera with Panorama View, Top View and 3D View.

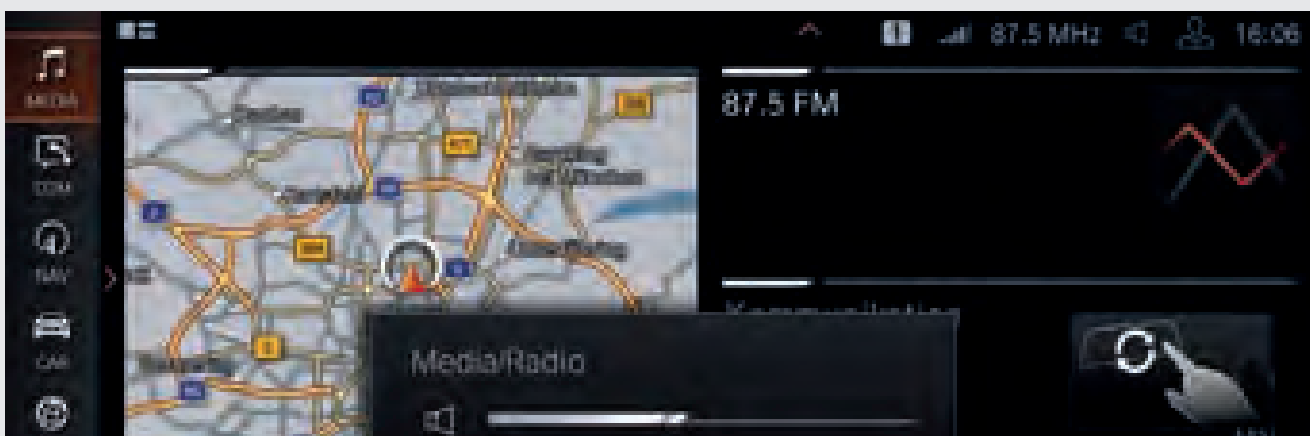

With **BMW Gesture Control**, certain functions can be operated by means of defined hand movements. For certain operations the system will for example recognise gestures such as swiping or pointing for accepting or rejecting an incoming call or circular motions of the index finger to adjust volume.

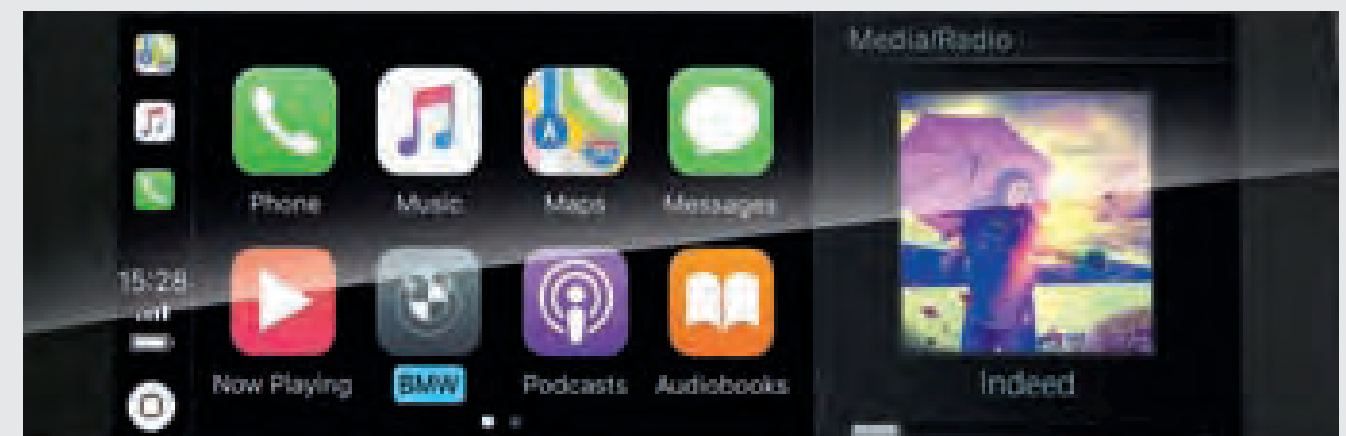

Why go without the features of your smartphone in your BMW when you can continue operating it as usual? With smartphone integration, your vehicle supports Apple CarPlay<sup>1,2</sup> and Android Auto by means of a wireless connection between your smartphone and the vehicle. This allows you to conveniently use familiar functions and various apps in the vehicle.

<sup>1</sup> Apps available on Apple CarPlay<sup>®</sup> is dependent on country specific offer by Apple.

<sup>2</sup> The compatibility and range of functions from Apple CarPlay<sup>®</sup> depend on the model year and the software installed on the iPhone<sup>®</sup>. When the Apple CarPlay<sup>®</sup> preparation is used, selected vehicle data is transferred to the phone. The mobile phone manufacturer is responsible for further data processing.



In laser high-beam mode, **BMW Laserlight with X Signature** illuminates a range of up to 600 m, nearly twice as far as that of conventional headlights. Better visibility in the dark significantly increases safety. The blue X signature and the "BMW Laser" lettering underline the vehicle's technological standards.

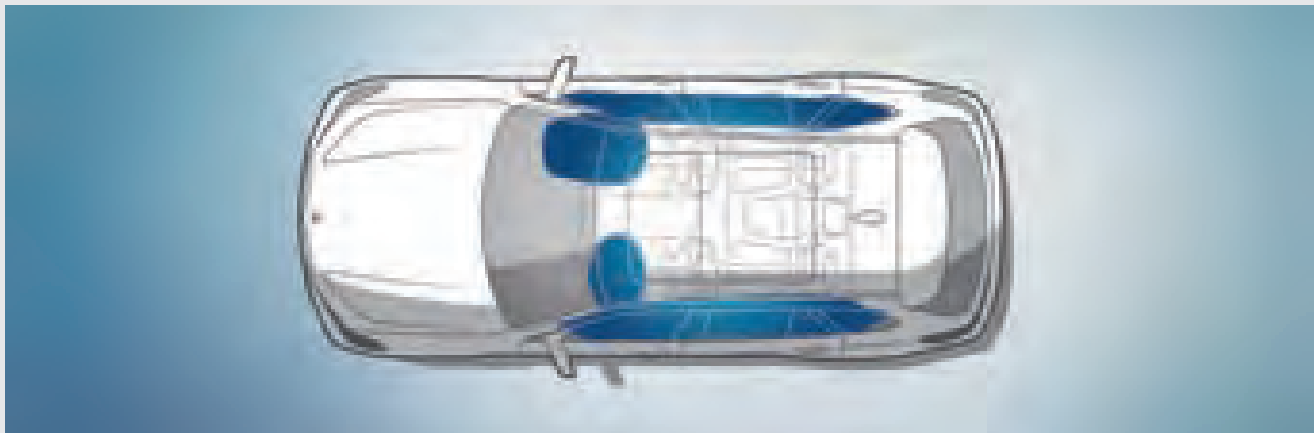

**Airbags** for driver and front passenger are part of the optimally coordinated safety components in a BMW. Overall, six airbags provide targeted protection: the driver and front passenger airbags, the head airbags for the entire window surface on the side, and the side airbags integrated into the front seat backrests.



**Dynamic Stability Control (DSC)** permanently assesses the vehicle's movements and stabilises it using engine and braking regulation when unstable driving conditions are detected. Additional features of DSC are, for example, brake drying, braking readiness or the Hill-Start assistant, which holds the vehicle briefly in place when starting on inclines to prevent it from rolling backwards.



The extremely torsionally stiff but **Light Body Construction** provides the basis for sporty driving dynamics, high precision steering and agility. Additionally, it offers passengers the best possible all-round protection.



**Anti-lock Brake System (ABS)** and **Cornering Brake Control (CBC)** help in preventing blocking of individual wheels when braking by means of targeted modulation of brake pressure and the vehicle from turning in when braking gently when subjected to a high degree of lateral acceleration by adjusting the control of the brake pressure.



The **Hill Descent Control (HDC)** in the BMW X5 is a system which, when activated ensures that the vehicle can master the steepest downhill runs automatically and safely at just above walking pace, without the driver having to brake.

**Standard model equipment:**

- Active Air Stream Kidney Grille
- LED Headlights and Taillights
- BMW Live Cockpit Professional with navigation
- 8-Speed Steptronic transmission
- Adaptive Suspension
- Cruise Control with braking function
- Electric Seat adjustment with memory (driver's side)
- 4-zone automatic air conditioning
- Panorama Glass Roof
- HiFi Loudspeaker System
- Parking Assistant with Rear View Camera
- BMW Gesture Control
- Wireless Smartphone Integration
- Automatic Operation of Tailgate
- Roller Sunblinds, rear side windows
- Ambient Light including dynamic interior light with Welcome Light Carpet
- Aluminium Running Board

**Exterior Design:**

- BMW Kidney Grille frame in high-gloss Chrome with grille struts in Pearl Chrome
- Exterior and central Air Inlets in front bumper in black high-gloss with embellisher in Pearl Chrome
- Side-window graphic in aluminium with satinised look
- Sump guard front and rear in black with grained look
- Side Skirts trim with trim strip in black high-gloss
- Roof Rails aluminium with satinised look
- Tailpipe trims in Chrome look
- 48.26 cm (19 inches) light alloy wheels V-spoke style 734

**Interior Design:**

- Door sill strips with 'BMW' designation
- Fine-wood trim ash grain brown-metallic high-gloss
- Sports seats with electrical adjustment
- Upholstery in high-quality Sensatec



<sup>1</sup> Apps available on Apple CarPlay® is dependent on country specific offer by Apple.

<sup>2</sup> The compatibility and range of functions from Apple CarPlay® depend on the model year and the software installed on the iPhone®. When the Apple CarPlay® preparation is used, selected vehicle data is transferred to the phone. The mobile phone manufacturer is responsible for further data processing.



**Exterior Design:**

- BMW Kidney Grille with exclusively designed vertical slats with front sides in aluminium with satinised look, grille frame in Pearl Chrome
- BMW Individual Exterior Line aluminium with window frame decorative moulding in satinised look
- Specific Air Inlets in aluminium with satinised look
- Air Breather in Pearl Chrome with surround in aluminium with satinised look
- Specific grilles in the front lateral air inlets in black high-gloss
- Side Skirts trim with trim strip in aluminium with satinised look
- Sump guard front and rear in stainless steel styling
- Tailpipe trims in aluminium with satinised look
- Roof Rails aluminium with satinised look
- Aluminium Running Board
- 50.80 cm (20 inches) light alloy wheels V-spoke style 738

**Interior Design:**

- Door sill strips with 'BMW' designation
- Instrument Panel in Sensatec
- Fine-wood trim poplar grain anthracite-brown open-pored
- Comfort seats with electrical adjustment
- Upholstery in high-quality Leather 'Vernasca' with design perforation
- Car key with chrome clasp





**Exterior Design:**

- MAerodynamics package with front apron, side skirts and wheel arch trims in body colour
- BMW Individual high-gloss Shadow Line
- M designation on the sides
- M sport brake with blue painted brake callipers with M designation
- Rear apron with Diffuser Insert
- Tailpipe finishers in M Sport package-specific geometry
- BMW Individual roof rails high-gloss Shadow Line
- 50.80 cm (20 inches) M light alloy wheels Star-spoke style 740 M Bicolor with mixed tyres

**Interior Design:**

- M door sill finishers and M-specific pedals
- Instrument Panel in Sensatec
- Comfort seats with electrical adjustment
- Upholstery in high-quality Leather 'Vernasca' with design perforation
- M Leather steering wheel
- BMW Individual headliner anthracite
- Fine-wood trim 'Fineline Stripe' in brown high-gloss
- M Sport package-specific car key





In laser high-beam mode, **BMW Laserlight with X Signature** illuminates a range of up to 600 m, nearly twice as far as that of conventional headlights. Better visibility in the dark significantly increases safety. The blue X signature and the "BMW Laser" lettering underline the vehicle's technological standards.

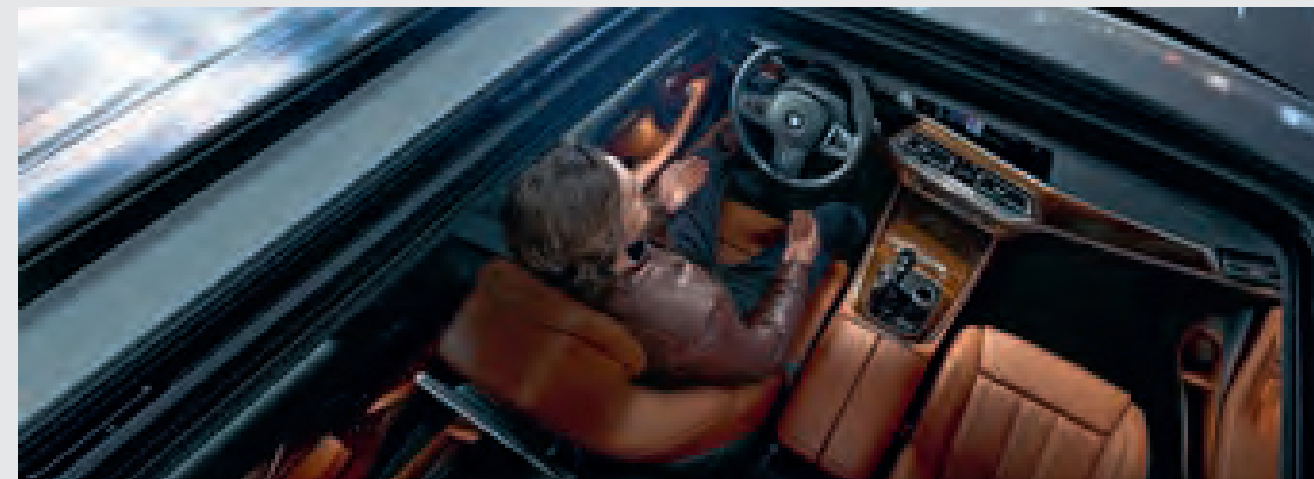

When open, the **Panorama Glass Roof** provides a great deal of fresh air. And when closed, it creates a bright, light-flooded atmosphere in the interior. It opens and closes completely automatically at the push of a button, and is equipped with slide and lift functions, roller sunblind and wind deflector.

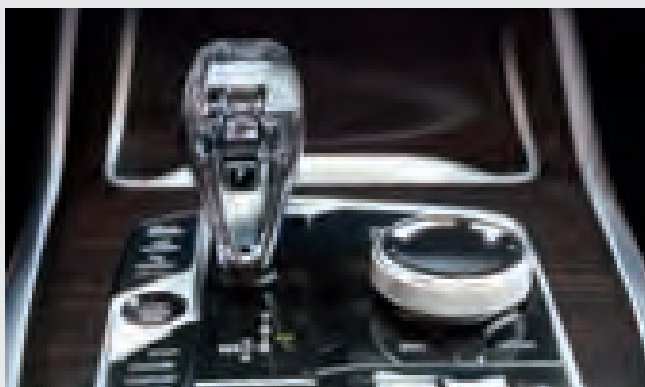

The **Crafted Clarity Glass Application** features a gear selector switch, iDrive controller and start / stop button made of hand-crafted crystal glass elements.



**Comfort Seats** upholstered in high-quality Leather 'Vernasca' and with electrical adjustment allow a perfect seating position.



The **Lumbar Support** for the driver and front passenger seats can be adjusted both vertically and laterally, allowing for an orthopaedically optimised seating position.

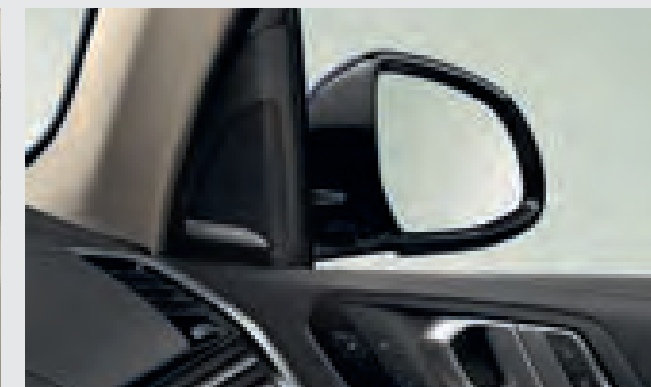

The tonally outstanding **Harman Kardon Surround Sound System** features a 464 W digital amplifier, nine channels and 16 speakers. Its sophisticated sound perfectly fills the interior space. Vehicle-specific, speed-dependent equalising precisely compensates for any background driving noise.

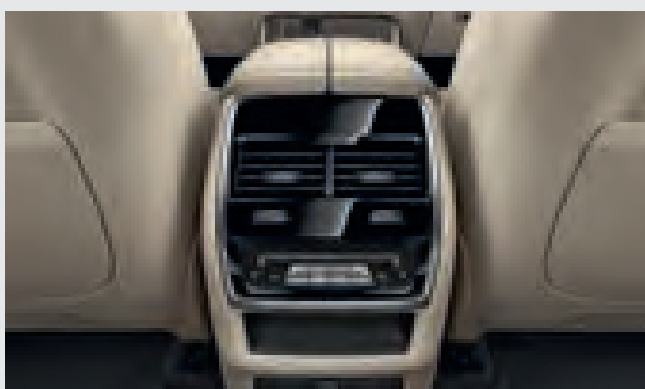

The **Automatic Air Conditioning with 4-zone Control** allows individual climate comfort for the driver and front passenger, as well as for the right and left rear passengers.

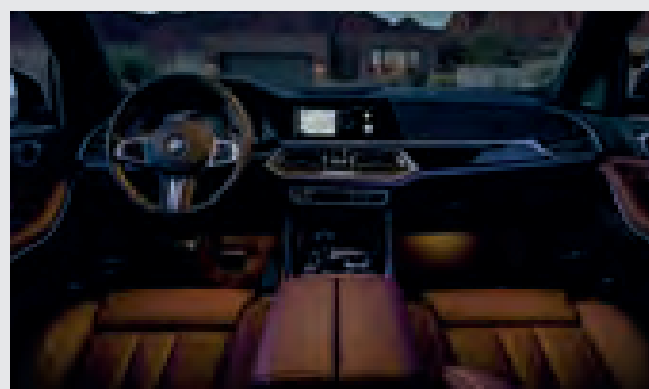

**Ambient light**, including Ambient contour lighting in the front and rear doors, creates a relaxed lighting atmosphere in the interior. Six dimmable light designs in White, Blue, Orange, Bronze, Lilac and Green are available.



The top of the **Instrument Panel** is covered in Sensatec. The sophisticated aesthetic of this high-quality trim gives the interior an even more luxurious feel.



The **Travel & Comfort System** includes two additional USB ports (type C) and a preparation for two multifunctional holders in the rear of the vehicle. Tablets, clothes hangers or folding tables, for example, can be attached to them.



The **Adaptive 2-axle Air Suspension** ensures extremely comfortable driving with great driving dynamics. The air suspension automatically keeps the vehicle at a constant height, regardless of the load. The driver can raise or lower the vehicle in an adjustment range of approx. 80 mm via a toggle switch in the centre console or via BMW Display Key.



The **BMW Live Cockpit Professional** with navigation function includes a high-quality display network consisting of a high-resolution 31.2 cm (12.3 inches) Info Display that can be operated by touch and a fully digital 31.2 cm (12.3 inches) instrument cluster.



The **Comfort Access System** makes it possible to open all of the vehicle doors without using the key and to start the vehicle by pressing a button, while the key remains in the pocket. The tailgate can be opened and closed without even being touched with a quick wave of the foot under the rear bumper.

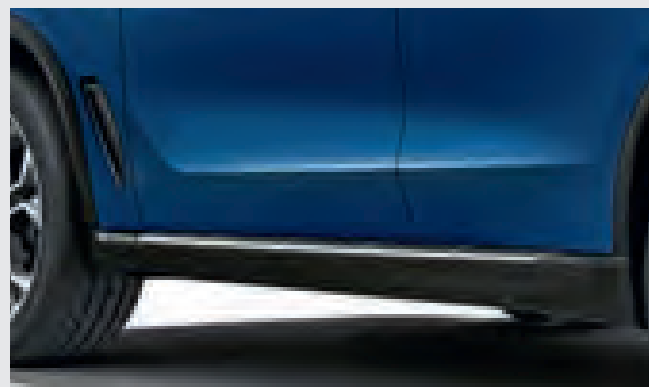

The **Aluminium running board** with a brushed, anodised surface and rubber inserts adds a particularly distinctive touch and makes getting in and out of the vehicle more convenient.

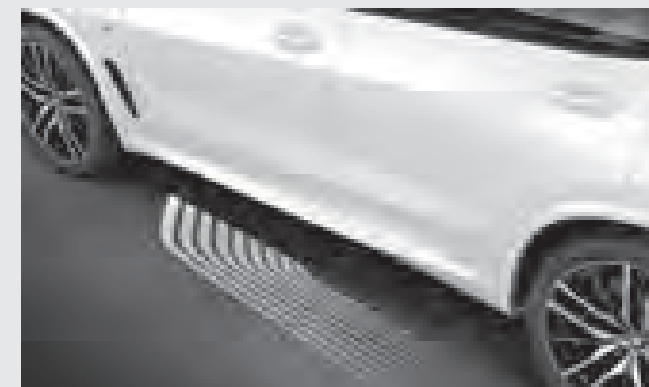

The **Welcome Light Carpet** illuminates the area in front of the car doors when entering and exiting.



The **BMW Display Key** shows various information about the vehicle's status and allows selected functions to be controlled with an integrated touch display.



Both the upper and the lower part of the **Tailgate** can be opened and closed electrically. This facilitates access and loading of the luggage compartment.

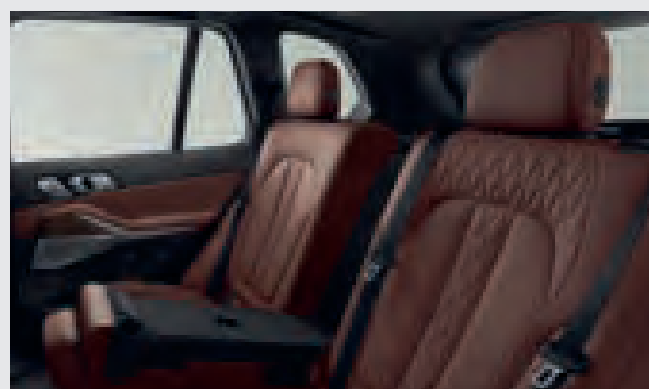

The rear backrest, dividable in a 40:20:40 split, offers great variability when it comes to transporting passengers and luggage.

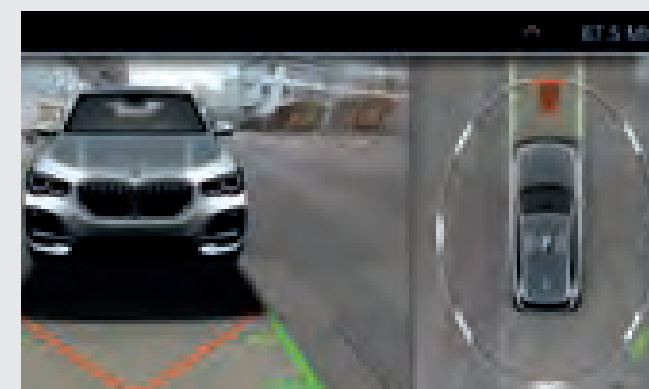

The **Parking Assistant with Surround View Camera** can handle the most difficult parking spots with ease. You can go in and out of parking spots with precision due to the system control the steering while you still have control of the accelerator, gears, and brakes.



The manually operated **Roller Sunblind** for the rear side window protects the interior from sunlight and offers privacy.



---

# ORIGINAL BMW ACCESSORIES.

---

As a proud BMW owner, accessories are customised to your own individual taste. Now you can further enhance your driving pleasure with Original BMW Accessories and personalise your BMW X5 for a greater level of luxury. Choose from our wide range of accessories specially designed for the interior, exterior, entertainment, connectivity, travel and comfort to suit your individual needs.





**M Performance Paddles, Carbon Fibre.** The M Performance paddles are covered with a very fine carbon fabric, finished in PUR paint and polished to a high gloss. The shift icons in M Red set additional motorsport highlights. Tiny details –fascinating impact.



**M Performance Side Skirt, Matt.** The M Performance side skirt foils in matt are perfectly tailored to the car's design and geometry. They lend the car an exceptionally sporty look.



**Rear Diffuser, Carbon Fibre.** The rear diffuser highlights the dynamic appearance of the rear of the vehicle in a highly individual manner. It perfectly blends in with the car's design.



**Rear Winglet, Carbon Fibre.** The rear winglets are a perfect supplement to the rear diffuser and make the rear of the car appear even wider and more sporty.



**Side Films in Frozen Black.** The Side Films in Frozen Black perfectly complement the vehicle's design, underscoring its individual, athletic profile. With coloured M Performance lettering.



**Exterior Mirror Caps, Carbon Fibre.** The striking carbon fibre exterior mirror caps underscore the vehicle's high-tech pedigree, adding an individual athletic touch.



**Air Inlet Front, Carbon Fibre.** The air inlet trims are perfectly tailored to the standard bumper, providing an opportunity to upgrade the front of the car with a high-quality carbon look.



**Front Winglet, Carbon Fibre.** The front winglets emphasise the width effect of the BMW X5 and give the car a more powerful front.



**M Performance Floor Mats, Front and Rear.** The M Performance floor mats perfectly round out the upscale, dynamic appearance of the car's interior.

## WHEELS AND TYRES.



50.80 cm (20 inches) Light Alloy Wheels Star Spoke Style 740M.



50.80 cm (20 inches) Light Alloy Wheels V-Spoke Style 738.



48.26 cm (19 inches) Light Alloy Wheels V-Spoke Style 734.



48.26 cm (19 inches) Light Alloy Wheels V-Spoke Style 735.

## UNIVERSAL ACCESSORIES.



**LED Door Projectors.** The innovative door projectors are automatically activated when the doors are opened. They project an image onto the ground next to the car using an interchangeable slide.



**Tyre Mobility Set.** With the intuitive BMW Mobility Set, damage on the tyre tread of less than 4 mm can be fixed. The set comprises a powerful compressor, tyre sealant, gloves and various valve adapters that can also be used.



**Fitted Luggage Compartment Mat.** The anti-slip, waterproof and durable mat with a border helps protect the luggage compartment.



**Advanced Car Eye 2.0.** A highly sensitive full-HD camera that captures events in front and behind the car, even when it is parked. In the event of disturbances and extraordinary movement outside the vehicle, the camera automatically records the situation in order to document possible accidents or (attempted) break-ins.



**Floor Mat.** The perfectly fitted, durable all-weather floor mats with raised border and elegant design protect the front and rear footwell from moisture and dirt. They are black and feature a black inlay.



**Child Seat Underlay and Backrest Cover.** Foam padding made of high-quality, robust polyester fabric to protect the seat from soiling and pressure marks. Wipe with a damp cloth to clean. Including backrest cover. Quick and stable attachment.



**Universal Hook.**<sup>1</sup> The universal hook makes it possible to hang items of clothing or light bags on the rear side of the backrest, protecting them from dirt in the footwell.



**BMW Leather Key Case.** The perfectly fitted key case, made from high-quality leather, is fixed to the key with a stylish metal clasp. It protects against scratches, dirt and moisture and protects buttons from accidental usage.

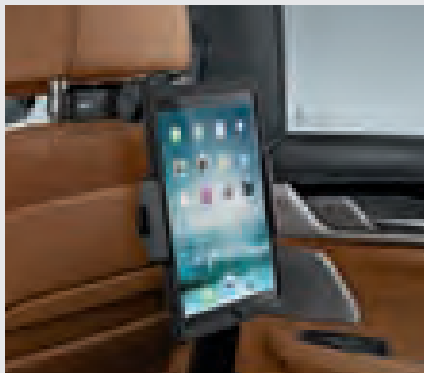

**Universal Cradle.**<sup>1</sup>

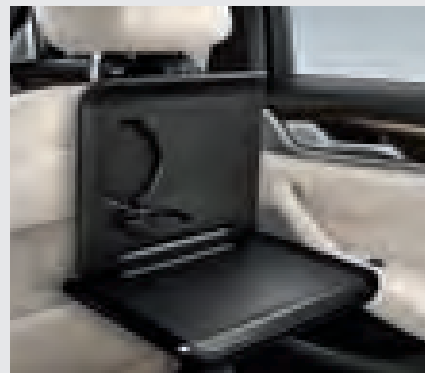

**Folding Table.**<sup>1</sup>



**BMW Display Key Case.** The precision-t case made from Nappa leather protects the BMW Display Key from dirt and scratches.



**BMW Baby Seat Group 0+.** The BMW Baby Seat Group 0+ with a five-point belt offers unsurpassed safety and comfort for babies up to approx. 13 kg (approx. 15 months old).

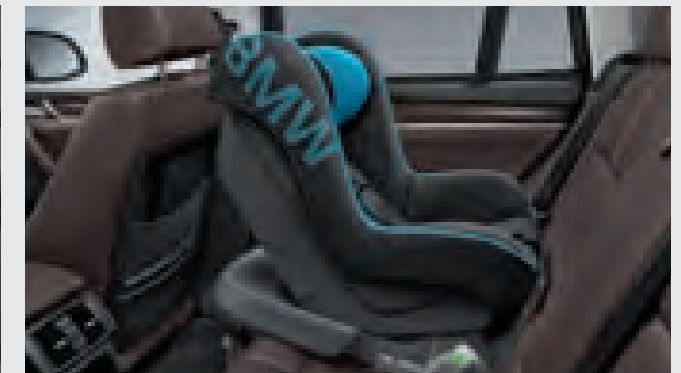

**BMW Junior Seat Group 1.** The BMW Junior Seat Group 1 is the safe choice for children from approx. 12 months to 4 years old (approx. 9–18 kg).



**Base Carrier.** Provides an option to attach clothes hangers, a folding table, universal hooks or holders for GoPro cameras, iPads™ or Samsung Galaxy Tabs to the front seat headrest.

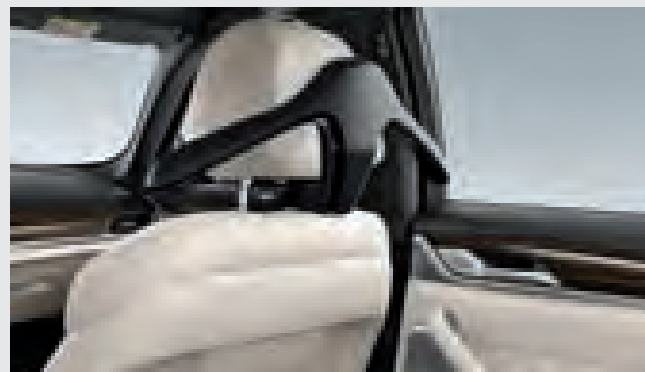

**Clothes Hanger.**<sup>1</sup> The Travel & Comfort System clothes hanger in an attractive BMW design makes it possible to hang pieces of clothing on the rear side of the backrest.

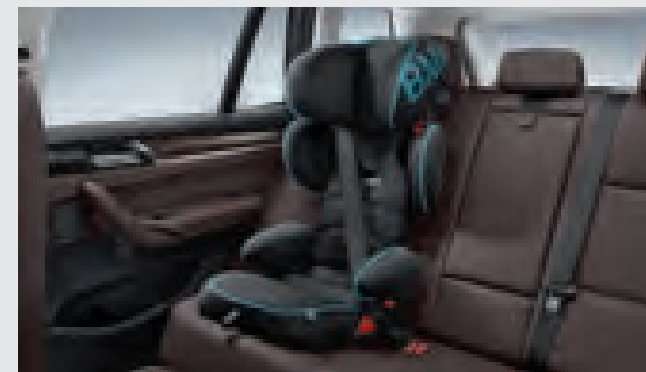

**BMW Junior Seat Group 2/3.** The BMW Junior Seat Group 2/3 can be adjusted as the child grows and offers maximum safety and comfort for children aged approx. 3 to 12 years (approx. 15–36 kg).



**The Travel Set.** Includes a carry-on sized trolley suitcase and a carry bag that help to create extra storage space in the rear seat. The luggage can be transported individually or stacked and secured with the safety belts. This feature locks to prevent theft.

<sup>1</sup> Only in conjunction with travel & comfort system/base carrier.

THE ART  
OF CAR CARE.



BMW Car Care Products are the BMW approved car cleaning products. Designed to keep your BMW in mint condition from the interior as well as the exterior. They also provide a protective shield against environmental conditions and preserve the high-quality finish of your vehicle.

# EXTERIOR COLOURS.



**Mineral White**  
(Metallic)

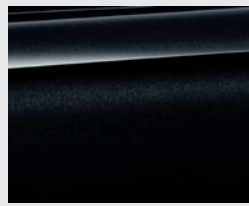

**Black Sapphire**  
(Metallic)

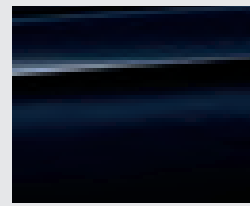

**Carbon Black**  
(Metallic)



**Phytonic Blue**  
(Metallic)

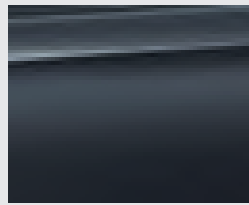

**Arctic Grey**  
(Metallic)

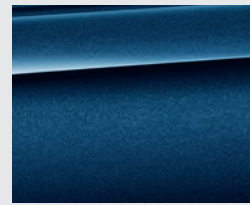

**Tanzanite Blue**  
(Metallic)

# INTERIOR COLOURS.

## UPHOLSTERY



**Leather 'Vernasca'**  
Design perforated  
Ivory White | Black



**Leather 'Vernasca'**  
Design perforated  
Coffee | Black

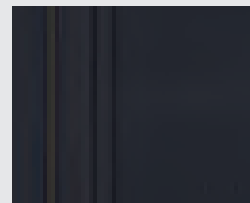

**Leather 'Vernasca'**  
Design perforated  
Black | Black



**Leather 'Vernasca'**  
Design perforated  
Cognac | Black

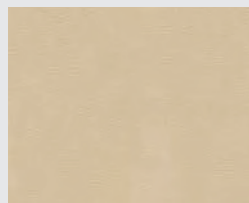

**Sensatec**  
Canberra Beige | Black

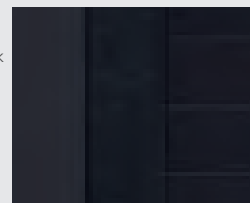

**Sensatec**  
Black | Black

## INTERIOR TRIMS

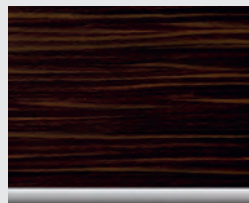

Fine-wood trim  
'Fineline Stripe'  
brown high-gloss

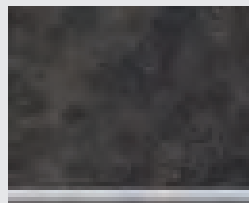

Fine-wood trim  
poplar grain  
anthracite-brown  
open-pored



Fine-wood trim ash  
grain brown-  
metallic high-gloss



# DIMENSIONS.

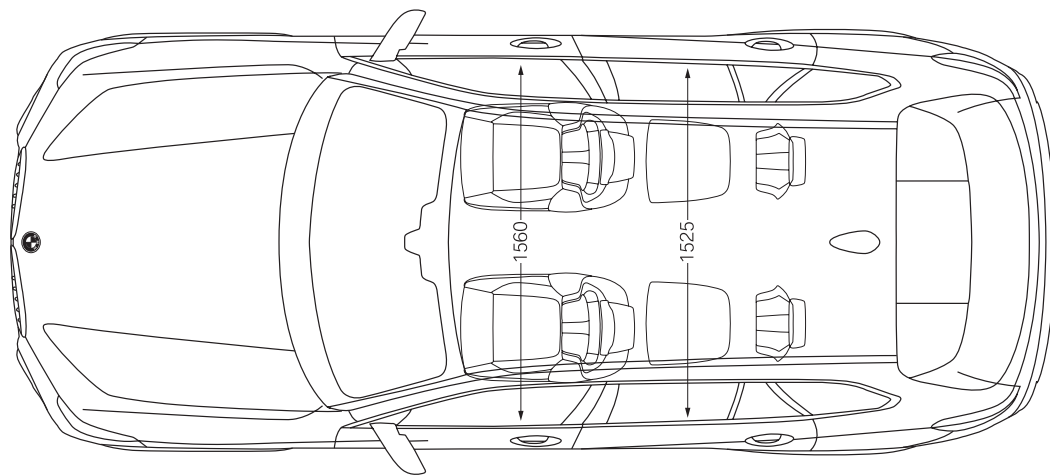
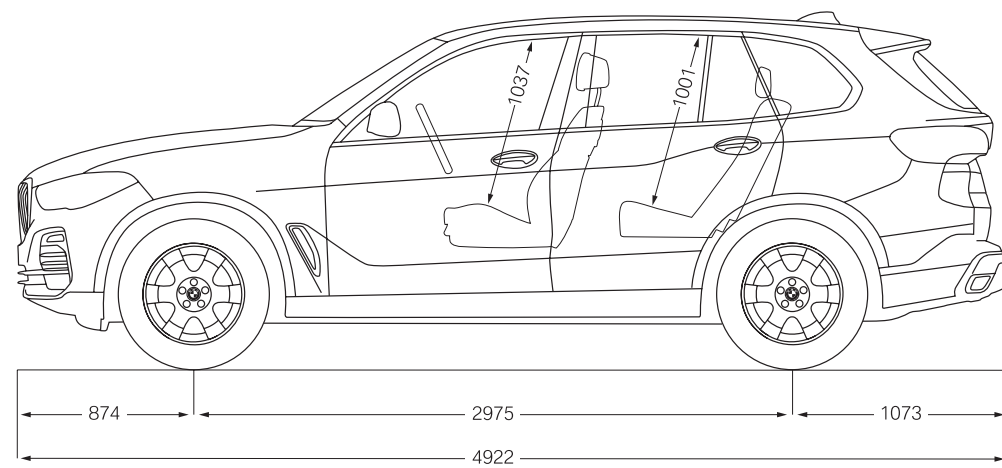
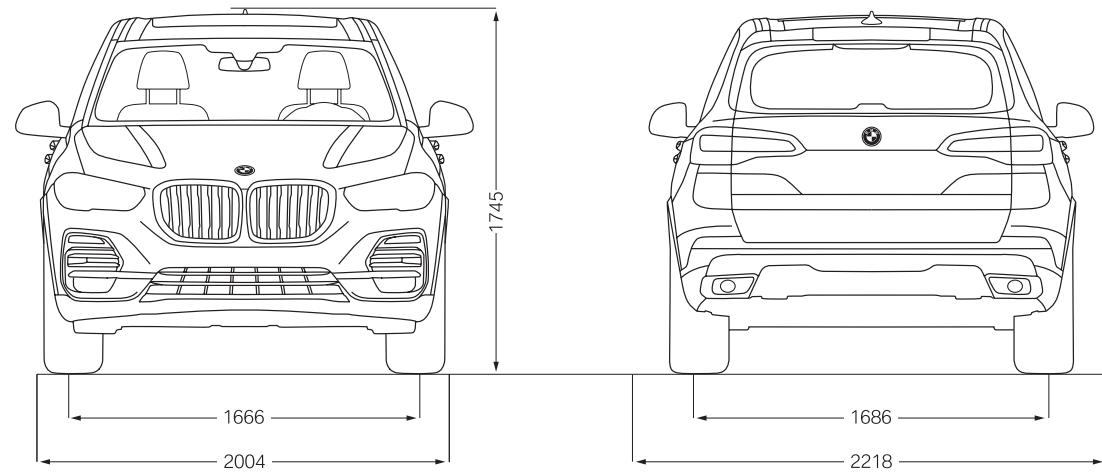

# BMW EXTENDED WARRANTY AND SERVICE PACKAGES.



A BMW will run well when it's kept well. And to make your journey one with complete peace of mind, we have packages under BMW Service and Repair Inclusive that take care of maintenance, inspection, wear and tear and warranty.

## BMW Service Inclusive (BSI)

A single up-front payment covers an extensive range of work on your BMW for a fixed period.

### Complete Cost Control.<sup>2</sup>

Integrate the cost of service work in your leasing and finance installments.

### Fully Flexible.

You have a choice of various packages with different durations and mileage. You can choose from 3 years with 40,000 km to 10 years with 2,00,000 km.

### Easily Transferable.

Consistent maintenance by trained BMW Service staff and the use of Original BMW Parts secure the value of your car in the long term. In case you sell your car, BMW Service Inclusive is automatically transferred to the next owner – an additional selling point.

## BMW Repair Inclusive (BRI)

BRI offers the ease of extending the warranty of your car with unlimited mileage up to 6 years.

BRI too is automatically transferred to the next owner in the event of selling your car.

## <sup>1</sup>Service packages starting at less than INR 1.55 per Km.

Service Inclusive Packages		Oil Inclusive	Service Inclusive Basic	Service Inclusive Plus	Repair Inclusive
Scope of Services		Maintenance Engine oil service.	Maintenance All maintenance work, including any BMW Original Parts and oil required.	Wear and Tear Additional wear and tear repairs including any Original BMW Parts required.	Repair Extension of your statutory right to claim for vehicle defects (warranty).
Maintenance	Engine oil service	✓	✓	✓	
	Engine oil top ups		✓	✓	
	Vehicle check and standard scopes		✓	✓	
	Service/replace air filter		✓	✓	
	Service/replace fuel filter		✓	✓	
	Service/replace micro filter		✓	✓	
	Service/replace spark plugs		✓	✓	
	Service/replace brake fluid		✓	✓	
Wear & Tear	Replacement of front/rear brake pads			✓	
	Replacement of front/rear brake discs			✓	
	Replacement of clutch (if necessary)			✓	
	Replacement of wiper blades (once in a year)			✓	
Extension of your statutory right to claim for vehicle defects (warranty <sup>1</sup> )					✓

# BMW FINANCIAL SERVICES.

**BMW Financial Services**  
Realize the dream.



In the world of BMW, world-class isn't limited to the vehicles we engineer. It also finds its way into the services we offer. BMW Financial Services is the most flexible and efficient way to realise your dream of owning a BMW. Our goal is to make your financing experience seamless at every step of your purchase so that nothing comes between you and the joy of driving your BMW.

At BMW Financial Services, you are assured of:

- Tailor-made finance options, as per your specific needs
- Quick approvals with fast turnaround time
- Special loyalty benefits
- Part payment facility
- In-house call centre that provides the best-in-class customer interaction

The BMW X5 comes with an exclusive BMW 360° Plan. It has benefits at every step of the way, all to ensure sheer driving pleasure.

### Easy to Buy.

The BMW 360° Plan allows you to pay low monthly installments as you only pay for what you use.

### Easy to Own.

BMW offers various options under service and maintenance packages which further reduce your cost of ownership.

### Future Proof.

The BMW 360° Plan provides Assured Buyback value at the end of your finance contract.

For more information, contact the Finance and Insurance Manager at the nearest BMW Authorised Dealership.

<sup>1</sup> Terms and Conditions apply. Prices are subject to change without any prior notice.

<sup>2</sup> Applicable only with BMW India Financial Services Private Limited during the initial purchase of the vehicle (not on other finance or during upgrades).



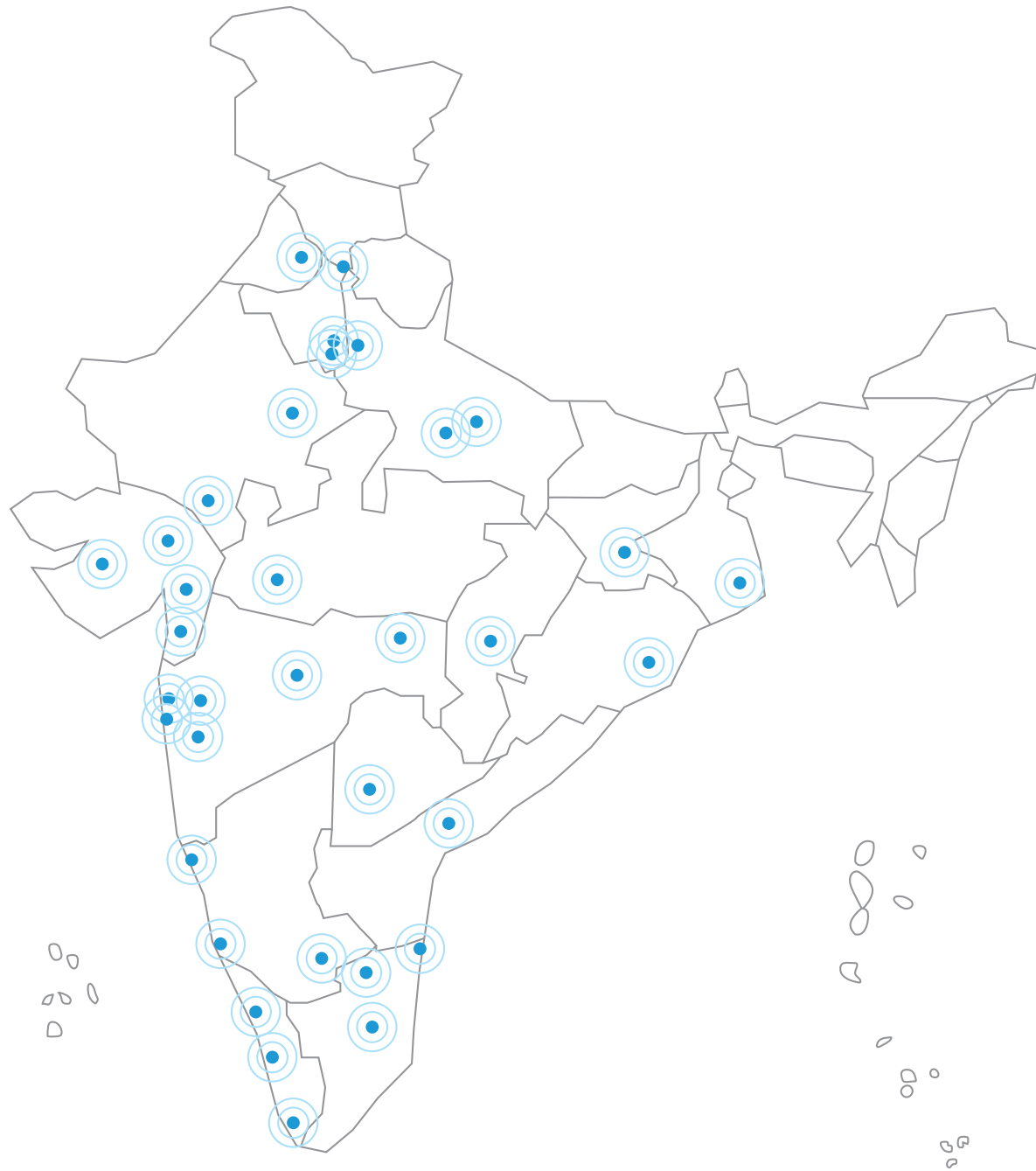

The pictorial representation does not purport to be the political map of India.

## NORTH

### BMW Bird Automotive

- SW 4IDC, MG Road, Gurugram
- S Golf Course Road, Sector 56 Gurugram

### BMW Deutsche Motoren

- S Mohan Cooperative, Mathura Road New Delhi
- W Shivaji Marg, Moti Nagar, New Delhi
- SW Sector 27B, Mathura Road, Faridabad
- SW Sector 63, Noida

### BMW Infinity Cars

- S Rajouri Garden, New Delhi
- W Mayapuri, New Delhi

### BMW Krishna Automobiles

- SW Industrial Phase 1, Chandigarh
- SW GT Road, Ludhiana

### BMW Sanghi Classic

- SW Tonk Road, Jaipur
- S Madri Industrial Area, Udaipur

### BMW Speed Motorwagen

- SW Chinhat, Lucknow
- SW Kalpi Road, Kanpur

## EAST

### BMW OSL Prestige

- S Silver Arcade, Kolkata
- W East Topsia Road, Kolkata
- SW Bhanpur, Cuttack

### BMW Titanium Autos

- SW Ormanjhi, Ranchi

## WEST

### BMW Bavaria Motors

- S Wellesley Road, Pune
- W Hadapsar, Pune
- SW Verna, Goa
- SW Chikalhana, Aurangabad

### BMW Eminent Cars

- SW Surat-Dumas Road, Piplod, Surat
- SW Sunpharma Road, Vadodara

### BMW Gallops Autohaus

- SW S G Highway, Sarkhej, Ahmedabad
- SW Gondal Road, Rajkot

### BMW Infinity Cars

- S Worli, Mumbai
- S Nariman Point, Mumbai
- S Vashi, Navi Mumbai
- W Lalbaug, Mumbai
- W Worli, Mumbai
- W Turbhe, Navi Mumbai
- SW Dewas Naka, Indore

### BMW Munich Motors

- SW Sarona, Raipur
- SW Hingna MIDC, Nagpur

### BMW Navnit Motors

- S Juhu, Mumbai
- S Malad, Mumbai
- W Andheri, Mumbai
- W Gokul Nagar, Thane

## SOUTH

### BMW Deutsche Motoren

- S Whitefield, Bengaluru
- W Whitefield, Bengaluru

### BMW EVM Autokraft

- SW Kalamassery, Kochi
- S Kovalam Road, Trivandrum
- W Kochuveli, Trivandrum

### BMW KUN Exclusive

- S Khairtabad, Hyderabad
- S Jubilee Hill, Hyderabad
- W RTC, Cross Road, Hyderabad
- SW Mangalagiri, Vijayawada

### BMW KUN Exclusive

- SW Meenambakkam, Chennai
- S EA Mall, Chennai
- S Ambattur, Chennai
- S OMR, Chennai
- W Ambattur, Chennai
- SW Avinashi Road, Coimbatore
- SW Virudhunagar, Madurai

### BMW Varsha Autohaus

- SW Mangalore-Bangalore Highway, Mangalore

### BMW Navnit Motors

- S Lavelle Road, Bengaluru
- W Bethahalasoor Post, Bengaluru
- SW Hosur Road, Bengaluru

SW Showroom and Workshop S Showroom W Workshop

SEARCH



Scan to visit the BMW Online Shop